

RX2N INSTRUCTION 
GP style meter
CDI & FI

Thank you for purchasing **KOSO RX2N GP style meter**, before operating the unit, please read the instruction thoroughly and retain it for the future reference.

Notice

1. The lcd meter is apply for **DC 12V**.
2. For installation, please follow the steps described in manual. Any damage caused by wrong installation shall be imputed to the users.
3. Don't break or modify the wire terminal. To avoid the short circuit, please don't pull the wire when installing.
4. Do not disassemble or change any parts excluding the manual description.
5. The interior examination or maintenance should be executed by our professionals.

MARK MEANING:

NOTE You could get the installation details from the information behind the mark.

 Some processes must be followed to avoid the affection caused by wrong installation.

WARNING! Some processes must be followed to avoid damages to yourself or the public.

CAUTION! Some processes must be followed to avoid the damage to the vehicle.

 Press the button one time

 Press the button 3 seconds

Content

1-1	Accessory	Attachment
1-2	Option accessory	Attachment
2-1	Wiring installation instructions	Attachment
2-2	Installation instructions	Attachment
3-1	Auto-checking screen	P03
3-2	Overview	P04
3-3	The button function instruction	P07
3-4	The screen switch instruction	P08

3-5	The main screen function switch instruction Select	P09
3-6	The main screen function switch instruction Adjust	P10
3-7	The setting screen instruction	P11
3-8	The power test screen instruction	P12
4	Function, setting instruction	P13
4-1	Speed unit setting	P15
4-2	Cycle / piston setting	P16
4-3	The temperature unit setting	P18
4-4	Speeding warning light setting	P19
4-5	The RPM shift light setting	P20
4-6	Over heat warning light setting	P21
4-7	Tire circumference and sensor point setting	P23
4-8	The clock setting	P25
4-9	The fuel gauge resistance and insufficient fuel warning setting	P26
4-10	The target speed timer / target distance timer setting	P28
5-1	 Target speed timer test	P30
5-2	 Target distance timer test	P32
5-3	 The top speed test	P34
6	Trouble shooting	P36
7	Guarantee & notice of products	P37
8	Guaranty	P38

 We recommend that you finish the relative setting before operating to assure the operation of meter.

3-1 Auto-checking screen



Off

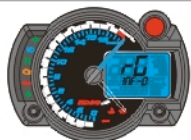

Check 5



Check 1



Check 6



Check 2



Check 7



Check 3



Check 8



Check 4



On

NOTE It will enter the setting screen automatically when the first time you start it.

3-2 Overview

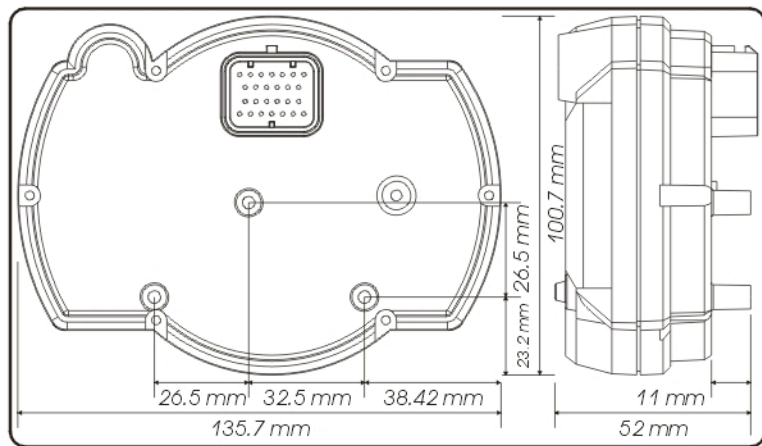

3-2 Overview

Fuel meter

- Display range: 10 levels.
- Setting range: 100 Ω, 510 Ω, no display.

Fuel warning

- Setting range: 10~50%
- Setting unit: 10%
- > Regarding the setting, please check 4-9.

Level thermometer (Water temperature)

- Display range: 20~120°C (68~248°F), 10 levels.
- Display unit: Each level represents 10°C (50°F)



Speeding warning light

- Setting range: 30~180 km/h (20~110 MPH).
- Setting unit: 5 km/h (MPH).
- > Regarding the setting, please check 4-4.



Indicators lights

- Repeater light (Green) ↔
- High beam light (Blue) ↗
- Neutral light (Green) N
- EOBD light (Amber) ⚠
- Engine oil pressure light (Red) ⚠

Over heat warning light (Water & oil temperature)

- Setting range: 60~250°C (140~482°F).
- Setting unit: 1°C (°F).
- > Regarding the setting, please check 4-6.



Clock ● 24H Digital thermometer (Water & oil temperature)

- Display range: 0~250°C (32~482°F)
- Display unit: 0.1°C (°F)



Tachometer (10,000 RPM)

- Display range: 0~10,000 RPM.
- Display unit: 250 RPM.

Tachometer (20,000 RPM)

- Display range: 0~20,000 RPM.
- Display unit: 500 RPM.

The RPM shift light (10,000 RPM)

- Setting range: 5,000~10,000 RPM.
- Setting unit: 100 RPM.

The RPM shift light (20,000 RPM)

- Setting range: 5,000~20,000 RPM.
- Setting unit: 100 RPM.

> Regarding the setting, please check 4-5.

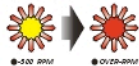

Speedometer

- Display range: 0~360 km/h, 0~223 MPH.
- Display unit: km/h & MPH for alternative.
- > Regarding the setting, please check 4-1.



The max RPM recall indicator light

- The indicator light will move according to the current RPM.
- The max RPM indicator light will show you the max RPM you reach and light on for 3 seconds.

Tachometer (10,000 RPM)

- Display unit: 250 RPM.
- Tachometer (20,000 RPM)
- Display unit: 500 RPM.



Odo meter

- Display range: 0~99999.9 km (mile), reset automatically after 99999.9 km.
- Display unit: 0.1 km (mile).

Trip meter A.B

- Display range: 0~999.9 km (mile), reset automatically after 999.9 km.
- Display unit: 0.1 km (mile).

MAX record

- The meter will record the top speed, RPM and temperature automatically.



3-3 The button function instruction

Select button

1. In main screen, press the **Select** button to choose the display of clock, water temperature or oil temperature.
2. In power test screen, press the **Select** button to choose the function you want to use.
3. In setting screen, press the **Select** to choose the function you want to set.

Select button X 3 seconds

1. In main screen, hold down the **Select** button for 3 seconds to enter the power test screen.
2. In power test screen, hold down the **Select** button for 3 seconds to back to the main screen.
3. In setting screen, hold down the **Select** button for 3 seconds to back to the main screen.



Adjust button

1. In main screen, press the **Adjust** button to choose the display of odometer, trip A, trip B or the MAX record.
2. In power test screen, press the **Adjust** button to reset the record, stop the testing, or restart the test.
3. In setting screen, press the **Adjust** button to make the number setting. If you keep pressing down the **Adjust** button the setting number will increase fast.

Adjust button X 3 seconds

In main screen, hold down the **Adjust** button for 3 seconds to reset the trip A, trip B, or the MAX record.

Hold down the adjust button

In setting screen, to add the setting value fast.

Select & adjust X 3 seconds

In main screen, hold down the **Select & Adjust** buttons at the same time for 3 seconds to enter the setting screen.



CAUTION! For safety reason - you could adjust the setting or operate the function only when the bike is stop.

3-4 The screen switch instruction



Select & Adjust X3S



Select X3S



In the setting screen, hold down the **Select** button for 3 seconds to back to the main screen.

In main screen, hold down the **Select & Adjust** button at the same time for 3 seconds to enter the setting screen.

In main screen, hold down the **Select** buttons for 3 seconds to enter the power test screen.

In power test screen, hold down the **Select** buttons for 3 seconds to back to the main screen.



In any screen, you could hold down the **Select** buttons for 3 seconds to back to the main screen.

3-5 The main screen function switch instruction *Select*



In main screen, press the **Select button** to choose the function combination you want to display on the screen.

The alternative combination is as the circle we list:
clock+fuel gauge > water temperature+fuel gauge > oil temperature+water temperature level gauge > clock+fuel gauge

NOTE If you don't install the fuel wiring, the fuel gauge will not display.

3-6 The main screen function switch instruction *Adjust*



In main screen, press the **Adjust button** to choose the function combination you want to display on the screen.

The alternative combination is as the circle we list:
odometer > trip A > trip B > MAX record.

3-7 The setting screen instruction



In setting screen, press the **Select button** to choose the function you want to set. The function in setting screen is in order as **speed unit, cycle and piston, temperature unit, speeding warning light, the RPM shift light, over heat warning light, tire circumference and sensor point, time, fuel gauge and insufficient warning, target speed timer test setting - target distance timer setting** and you could finish the setting as the order. After finishing the setting, press down the **Select button** to leave the setting screen.

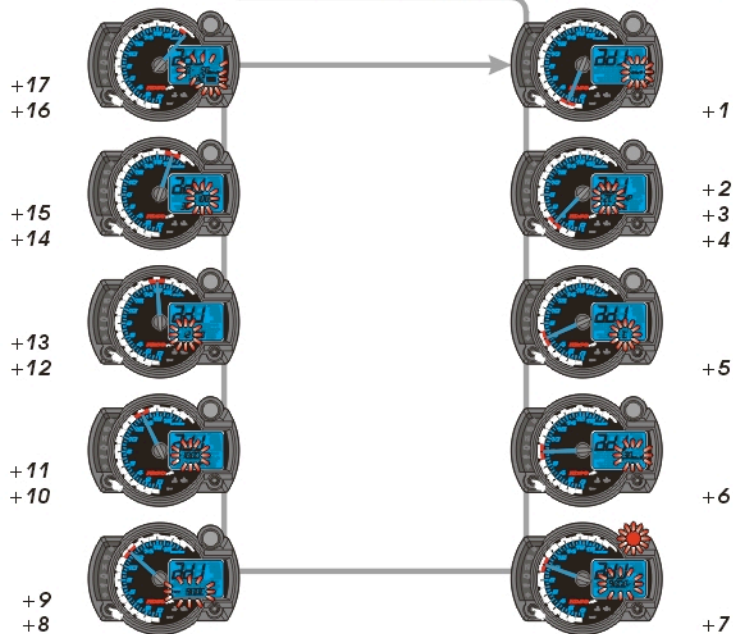

NOTE If you enter the setting screen for 30 seconds and don't press the button, it will back to the main screen automatically.

3-8 The power test screen instruction



In power test screen, press the **Select button** to choose the test you want to do. The test function is in order as **target speed timer, target distance timer, top speed timer**.

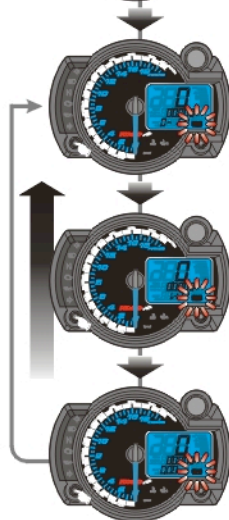

In power test screen, press the **Select button** to switch from the target speed timer to target distance timer.
EX. Now it is in the target speed timer screen, and the setting is 0~110 km/h.

In power test screen, press the **Select button** to switch from the target distance timer to the top speed timer screen.
EX. Now the screen switch from the target speed timer screen to the target distance timer screen, and the setting is 0~100 M (2/32 mile).

In power test screen, press the **Select button** to switch from the top speed timer to the target speed timer.
EX. Now the screen switch from the target distance timer screen to the top speed timer screen, and the setting is 0~100 M (2/32 mile).

4 Function, setting instruction

●Speedometer	Display range: 0~360 km/h (0~223 MPH) Display unit: km/h & MPH for alternative
○Display interval	<0.5 second
○Odometer	Display range: 0~99999.9 km (mile), reset automatically after 99999.9 km (mile).
○Trip meter A/B	Display range: 0~999.9 km (mile), reset automatically after 999.9 km (mile)
○Speeding warning light	Setting range: 30~180 km/h (20~110 MPH) Setting unit: 5 km/h (MPH)
○Top speed record	Display range: 0~360 km/h (0~223 MPH)
○Tire circumference	Setting range: 300~2,500 mm Setting unit: 1 mm · Sensitive point: 1~60
●Tachometer	Display range: 0~10,000 / 20,000 RPM Display unit: 250 / 500 RPM
○Display interval	<0.5 second
○Shift light	Setting range: 5,000~10,000 / 20,000 RPM Setting unit: 100 RPM
○MAX RPM record	Display range: 0~10,000 / 20,000 RPM
○Stroke / piston setting	2 Stroke: 1, 2, 3, 4 pistons 4 Stroke: 1, 2, 3, 4, 5, 6, 8, 10, 12 pistons
●Thermometer	Display unit: °C & °F for alternative
●Digital thermometer	Display range: 0~250°C (32~482°F) (Water & oil temperature) Display unit: 0.1°C (°F)
●Level thermometer	Display range: 20~120°C (68~248°F), 10 levels (Water temperature) Display unit: Each level represents 10°C (50°F)
○Display interval	<0.5 second
○Over heat warning light	Setting range: 60~250°C (140~482°F) (Water & oil temperature) Setting unit: 1°C (°F)

○Top temperature record	Display range: 0~250°C (32~482°F)
●Fuel meter	Display range: 10 levels Display unit: Each level represents 10 % Setting range: 100 Ω, 510 Ω, no display
○Insufficient fuel warning	Setting range: 10~50 % Setting unit: 10 %
●Clock	24 H
●Target speed timer	Setting range: 30~360 km/h (20~220 MPH) Setting unit: 5 km/h (MPH)
●Target distance timer	Setting range: 50~1,000 M (1/32~20/32 mile) Setting unit: 50 M (1/32 mile)
●Top speed timer	The record including, 1.Speed: 0~360 km/h (0~223 MPH) 2.Distance: 0~999 M (0~3,280 feet) 3.RPM: 0~10,000 / 20,000 RPM 4.Timer: 0~9'59"99 second.
●Effective voltage	DC 12V
●Effective temperature range	-10~+60°C
●Meter standard	JIS D 0203 S2
●Meter size	135.7 X 100.7 X 52 mm
●Meter weight	Around 240 g
●Indicator light color	Neutral-green, High beam-blue, Repeater-green, EOBD-amber, Oil-red, Speeding-red, RPM shift light yellow / red.

NOTE Design and specification are subject to change without notice!

4-1 Speed unit setting



In setting screen, press the **Select button** one time to enter the speed unit setting.



Press the **Adjust button** to choose the speed unit.
EX. Now the setting is km/h.

⚠ Now the speed unit is flashing!

NOTE You could choose km/h or MPH in the speed unit setting screen.

⚠ The odometer & trip meter will change together with the speed unit.



Press the **Select button** to continue the function setting.

NOTE When you leave this screen, the setting is finished.

👉 If you just want to make this function setting, you could hold down the **Select button** for 3 seconds to back to the main screen.

4-2 Cycle / piston setting



In setting screen, press the **Select button** 2 times to enter the stroke/piston setting screen.

⚠ CAUTION!

- Make sure the correct strokes and pistons before setting.
- Make sure the input is correct, or the RPM output will be incorrect.
- We define the engine with the ignition system ignites every 360 degree as 2-stroke and the engine with the ignition system ignites every 720 degree as 4-stroke.
- Some 4-stroke bikes with one single piston are igniting every 360 degree once, so the setting should be the same as the bike with 2-stroke and one piston engine.



Press the **Adjust button** to select the stroke.
EX. Now the stroke number is flashing.

⚠ Now the stroke setting number is flashing!

NOTE You could set the stroke as 2 Cycle or 4 Cycle.

👉 If you just want to check your setting, you could hold down the **Select button** for 3 seconds to back to the main screen.



Press the **Select button** to enter the piston setting screen.
EX. Now the setting is changed from 2 Cycle to 4 Cycle.



Press the **Adjust button** to select the piston number.

⚠ Now the piston number is flashing.

NOTE 2 Cycle: 1, 2, 3, 4 pistons
4 Cycle: 1, 2, 3, 4, 5, 6, 8, 10, 12 pistons

Next page

4-2 Cycle / piston setting



Press the **Select button** to enter the signal input setting.
EX. The piston setting is changed from 1 P (Piston) to 4 P (Pistons).

Press the **Adjust button** to choose the input signal you want to set.

⚠ Now the input signal setting is flashing!

NOTE The input signal setting range is between high (The positive signal) & low (The negative signal)

NOTE If the tachometer can't detect the signal (No RPM is displayed on the screen), you could choose another setting, and check it again.

Press the **Select button** to enter other setting screen.
EX. The input signal is changed from high to low.

NOTE When you leave this screen, the setting is finished.

🔄 If you just want to make this function setting, you could hold down the **Select button** for 3 seconds to back to the main screen.

4-3 The temperature unit setting



In setting screen, press the **Select button** 5 times to enter the temperature unit setting screen.

Press the **Adjust button** to choose °C or °F.
EX. Now the temperature unit is °C.

⚠ Now the temperature unit is flashing!

Press the **Select button** to continue the function setting.
EX. Now the temperature unit is changed from °C to °F.

NOTE When you leave this screen, the setting is finished.

🔄 If you just want to make this function setting, you could hold down the **Select button** for 3 seconds to back to the main screen.

4-4 Speeding warning light setting



In setting screen, press the **Select button** 6 times to enter the speeding warning light setting screen.

The speeding light will light on when the speed reaches your speeding warning setting.



Press the **Adjust button** to choose the setting number. EX. Now the speeding warning light setting is 30 km/h.

⚠ Now the speeding warning light and the setting is flashing!

NOTE The speeding warning light setting range: 30~180km/h (20~110 MPH).
Setting unit: 5 km/h (MPH)

⚠ The setting unit will change together with the speed unit setting (4-1).

🔄 If you just want to check your setting, you could hold down the **Select button** for 3 seconds to back to the main screen.



Press the **Select button** to continue the function setting.

EX. Now the setting is changed from 30 km/h to 60 km/h.

NOTE When you leave this screen, the setting is finished.

🔄 If you just want to make this function setting, you could hold down the **Select button** for 3 seconds to back to the main screen.

4-5 The RPM shift light setting



In setting screen, press the **Select button** 7 times to enter the RPM shift light setting screen.

If you set the RPM shift light at 12,000 RPM, the yellow light will light on at 11,500 RPM and the red light will light on when it reaches 12,000 RPM.



Press the **Adjust button** to choose the setting number. EX. Now the RPM shift light setting is 9,000 RPM.

⚠ Now the shift light and the setting number is flashing!

NOTE The over RPM warning setting range: 3,000~15,000 RPM.
Setting unit: 100 RPM.



Press the **Select button** to continue the function setting.

EX. Now the RPM shift light setting is changed from 9,000 RPM to 12,000 RPM.

NOTE When you leave this screen, the setting is finished.

🔄 If you just want to make this function setting, you could hold down the **Select button** for 3 seconds to back to the main screen.

4-6 Over heat warning light setting



In setting screen, press the **Select button** 8 times to enter the over heat warning light (Water temperature) setting screen.

The temperature logo on LCD will flash when the temperature reached your setting.



Press the **Adjust button** to choose the setting number.

EX. Now the over heat warning (Water temperature) setting is 90.0°C.

⚠ Now the water temperature logo and the setting number are flashing!

NOTE The over heat warning light setting range: 60~ 250°C (140~ 482°F).
Setting unit: 1°C (°F).

⚠ The setting unit will change together with the temperature unit setting (4-3).

🔄 If you just want to check your setting, you could hold down the **Select button** for 3 seconds to back to the main screen.



Press the **Select button** to enter the over heat warning light (Oil temperature) setting.
EX. Now the setting is changed from 90.0°C to 95.0°C.

Next page



Press the **Adjust button** to choose the setting number.

EX. Now the over heat warning light (Oil temperature) setting is 90.0°C.

⚠ Now the oil temperature logo and the setting number are flashing!

NOTE The over heat warning light setting range: 60~ 250°C (140~ 482°F).
Setting unit: 1°C (°F).



Press the **Select button** to continue the function setting.

EX. Now the setting is changed from 90.0°C to 95.0°C.

NOTE When you leave this screen, the setting is finished.

🔄 If you just want to make this function setting, you could hold down the **Select button** for 3 seconds to back to the main screen.

4-7 Tire circumference and sensor point setting



In setting screen, press the **Select button** 10 times to enter the Tire circumference and sensor point setting screen.

⚠ CAUTION!

- Please measure the tire circumference (The tire you will install the sensor on) and make sure the number of magnet sensor point (You could install the magnet into the disc screw or the sprocket screw.)
- The speed displayed on the meter will be affected by the setting, please make sure the setting number is correct before you make the setting.



Press the **Adjust button** to choose the setting number.
EX. Now the tire circumference setting is 1,000 mm, and the sensor point is 1.

⚠ Now the circumference setting number is flashing!

NOTE The tire circumference setting range: 300~2,500 mm. Setting unit: 1 mm.

 If you just want to check your setting, you could hold down the **Select button** for 3 seconds to back to the main screen.



Press the **Select button** to enter the sensor point setting.
EX. The circumference setting is changed from 1,000 mm to 1,300 mm.

Press the **Adjust button** to choose the setting number.

Now the sensor point setting number is flashing!

NOTE The sensor point setting range: 1~60 points.

Press the **Select button** to continue the function setting.
EX. the sensor point setting is changed from 1 P to 6 P.

NOTE When you leave this screen, the setting is finished.

 If you just want to make this function setting, you could hold down the **Select button** for 3 seconds to back to the main screen.

P.S.



You could define the valve as the starting point and the terminal point to measure the wheel circumference with a measuring tape.

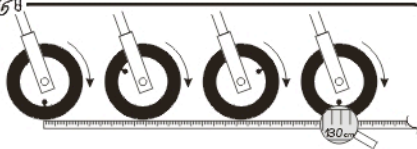

Next page

RX2N P23

RX2N G24

4-8 The clock setting



In setting screen, press the **Select button** 12 times to enter the clock setting screen.



Press the **Adjust button** to choose the setting number.

EX. Now the time is 0:00.

▲ Now the hour number is flashing!

NOTE This is a 24 H clock.



Press the **Select button** to enter the minute setting.

EX. Now the hour is changed from 0 to 13.



Press the **Adjust button** to choose the setting number.

▲ Now the minute number is flashing!



Press the **Select button** to continue the function setting.

EX. the minute is changed from 0 to 1.

NOTE When you leave this screen, the setting is finished.

If you just want to make this function setting, you could hold down the **Select button** for 3 seconds to back to the main screen.

4-9 The fuel gauge resistance and insufficient fuel warning setting



In setting screen, press the **Select button** 14 times to enter the fuel gauge resistance and insufficient fuel warning setting screen.



Press the **Adjust button** to choose the setting number.

EX. Now the fuel gauge resistance setting is 100 Ω and the insufficient setting is 30 %.

▲ Now the resistance setting number is flashing!

NOTE The fuel gauge resistance setting range : 100 Ω , 510 Ω .

If you don't install the fuel wiring, the fuel gauge will not display.

If you just want to check your setting, you could hold down the **Select button** for 3 seconds to back to the main screen.

PS. Usually the fuel gauge resistance is 100 Ω on YAMAHA system, and 510 Ω on HONDA system.
The insufficient fuel warning setting: When the fuel is less than your setting, the fuel level gauge will flash to warn you.



Press the **Select button** to enter the insufficient fuel warning setting.

EX. Now the fuel resistance setting is changed from 100 Ω to 510 Ω .

Next page

4-9 The fuel gauge resistance and insufficient fuel warning setting



Press the **Adjust button** to choose the setting number.

⚠ Now the insufficient setting number is flashing!

NOTE The insufficient fuel warning setting range: 10~ 50 %. Setting unit: 10 %.



Press the **Select button** to continue the function setting.

EX. the setting is changed from 30 % to 20 %.

NOTE When you leave this screen, the setting is finished.



If you just want to make this function setting, you could hold down the **Select button** for 3 seconds to back to the main screen.

4-10 The target speed timer / target distance timer setting



In setting screen, press the **Select button** 16 times to enter the target speed timer setting screen.

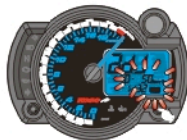

Press the **Adjust button** to choose the setting number.

EX. The target speed timer setting is 0~ 50 km/h and the target distance timer setting is 1/32 mile (50 M).

⚠ Now the  and target speed number is flashing!

NOTE The target speed timer setting range: 30~ 360 km/h (20~ 220 MPH).
Setting unit: 5 km/h (MPH).

⚠ The setting unit will change together with the speed unit setting (4-1).



If you just want to check your setting, you could hold down the **Select button** for 3 seconds to back to the main screen.



Press the **Select button** to enter the target distance timer warning setting.

EX. Now the target speed timer is changed from 0~ 50 km/h to 0~ 110 km/h.



Press the **Adjust button** to choose the setting number.

⚠ Now the  and target distance number is flashing!

NOTE The target distance timer setting range: 50~ 1,000 M (1/32~ 20/32 mile).
Setting unit: 50 M (1/32 mile).

Next page

4-10 The target speed timer / target distance timer setting *Power TEST*



Press the **Select button** to continue the function setting.

EX. Now the target distance timer setting is changed from 1/32 mile (50 M) to 2/32 mile (100 M).

NOTE When you leave this screen, the setting is finished.



If you just want to make this function setting, you could hold down the **Select button** for 3 seconds to back to the main screen.

5-1 *Power TEST* Target speed timer test



⚠ WARNING!

Please use this function at racetrack to avoid traffic accidents.

In power test screen, press the **Select button** one time to enter the target speed timer test screen.

NOTE Please start the test when the bike stops.

⚠ If you have the power test record, it will display the record first. You must clear the record before starting a new test.

Enter the testing screen if no record

The record display screen



Enter the testing screen



Next page

Press the **Adjust button** to clear the record and enter the target speed timer test screen.

EX. Now you could see the record you have before. It displays the target speed timer setting as 0~ 110 km/h, the test result: 19"20 seconds. The top speed is 110 km/h during the test. The MAX RPM is 10,000 RPM during the test.



If you just want to check the record, you could hold down the **Select button** for 3 seconds to back to the main screen.

When the bike moves, the timer will start automatically.

⚠ Now the **rec** is flashing!

NOTE About the power test setting, please check 4-10.

5-1 Power TEST Target speed timer test



The timer is automatic, so when your bike start to move the timer will start to count the time and stop automatically after you stops the bike.

⚠ During the test, the **PS.** will keep flashing!



When you reach the target speed you set (0~110 km/h), the timer will stop counting (19'20 second).

👉 If you just want to use the function one time, hold down the **Select** button for 3 seconds to save the records and back to the main screen.

If you want to test it again, press the **Adjust** button to clear the record and enter the target speed timer test screen again.

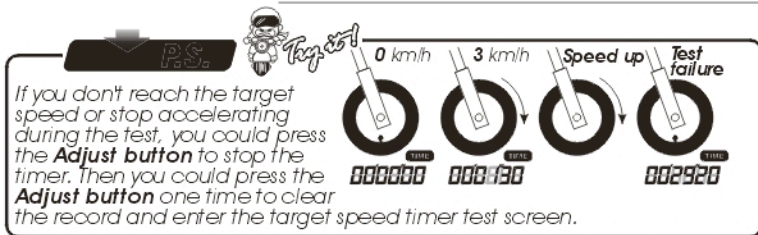

If you don't reach the target speed or stop accelerating during the test, you could press the **Adjust** button to stop the timer. Then you could press the **Adjust** button one time to clear the record and enter the target speed timer test screen.

5-2 Power TEST Target distance timer test



⚠ WARNING!

Please use this function at racetrack to avoid traffic accidents.

In power test screen, press the **Select** button 2 times to enter the target distance timer test screen.

NOTE Please start the test when the bike stops.

⚠ If you have the power test record, it will display the record first. You must clear the record before starting a new test.

Enter the testing screen if no record

The record display screen



Press the **Adjust** button to clear the record and enter the target distance timer test screen. EX. Now you could see the record you have before. It displays the target speed timer setting as 2/32 mile (100 M), the test result: 10'27 seconds. The top speed is 63 km/h during the test., The MAX RPM is 8,000 RPM during the test.

👉 If you just want to check the record, you could hold down the **Select** button for 3 seconds to back to the main screen.

Enter the testing screen



Next page

When the bike moves, the timer will start automatically.

⚠ Now the **PS.** is flashing!

NOTE About the power test setting, please check 4-10.

5-2 Power TEST Target distance timer test

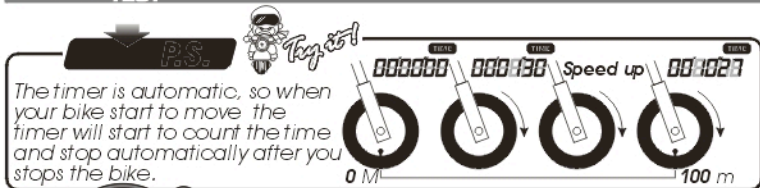

The timer is automatic, so when your bike start to move the timer will start to count the time and stop automatically after you stops the bike.

⚠ During the test, the **PS.** will keep flashing!



When you reach the target distance you set (100 M . 2/32 mile), the timer will stop counting (10"27 second).

👉 If you just want to use the function one time, hold down the **Select** button for 3 seconds to save the records and back to the main screen.

If you want to test it again, press the **Adjust** button to clear the record and enter the target speed timer test screen again.

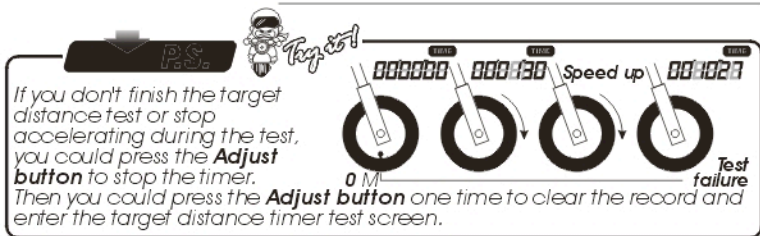

If you don't finish the target distance test or stop accelerating during the test, you could press the **Adjust** button to stop the timer. Then you could press the **Adjust** button one time to clear the record and enter the target distance timer test screen.

5-3 Power TEST The top speed test



⚠ WARNING!

Please use this function at racetrack to avoid traffic accidents.

In power test screen, press the **Select** button 3 times to enter the top speed test screen.

📌 NOTE Please start the test when the bike stops.

⚠ If you have the power test record, it will display the record first. You must clear the record before starting a new test.

Enter the testing screen if no record

The record display screen



Enter the testing screen



Next page

Press the **Adjust** button to clear the record and enter the top speed test screen.
EX. Now you could see the record you have before. It displays the top speed is 180 km/h, the distance to reach the top speed is 510 M, The MAX RPM is 10,000 RPM during the test, the time you need to reach the top speed is 10"20 seconds.

👉 If you just want to check the record, you could hold down the **Select** button for 3 seconds to back to the main screen.

When the bike moves, the timer will start automatically.

⚠ Now the **PS.** is flashing!

📌 NOTE The top speed test range:
Speed: 0~ 360 km/h. Distance: 0~ 999 M (3280 feet) RPM: 0~ 10,000 / 20,000 RPM. Timer: 0~ 9'59"99 seconds.

⚠ The setting unit will change together with the speed unit setting (4-1).

5-3 **Power TEST** The top speed test



The timer is automatic, so when your bike starts to move, the timer will start to count the time and stop automatically after you stop the bike.

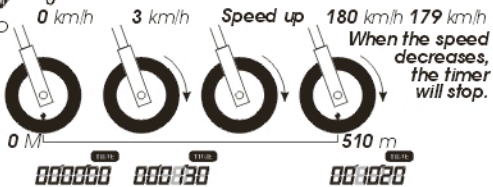

⚠ During the test, the **PS** will keep flashing!



When you reach the top speed (180 km/h), the meter will stop counting the distance (510 M), and time (10'20 seconds).

👉 If you just want to use the function one time, hold down the **Select** button for 3 seconds to save the records and back to the main screen.

If you want to test it again, press the **Adjust** button to clear the record and enter the target speed timer test screen again.

6 Trouble shooting

The following situation do not indicate malfunction of the meter. Please check the following before taking it in for repair.

Trouble	Check item
The meter doesn't work when the power is on.	<ul style="list-style-type: none"> ● The power doesn't supply to the meter. <ul style="list-style-type: none"> → Please make sure the wiring is connected. The wiring and fuse are not broken. → The battery is broken or the battery is too old to supply enough power DC 12V to make the meter work.
The meter shows wrong information.	<ul style="list-style-type: none"> ● Please check the voltage of your battery, and make sure the voltage is over DC 12V.
Speed does not appear or appear incorrectly.	<ul style="list-style-type: none"> ● Please make sure the speed sensor is connected correctly. ● Please check the tire-size setting. <ul style="list-style-type: none"> → please refer to the manual 4-7.
Tachometer does not appear or appear incorrectly.	<ul style="list-style-type: none"> ● Please check the RPM sensor wiring is connected correctly. ● Please check the spark plug is R type or not. If not, please replace the spark plug with the R type spark plug. ● Please check your setting. <ul style="list-style-type: none"> → Please refer to the manual 4-2.
Fuel gauge does not appear or appear incorrectly.	<ul style="list-style-type: none"> ● Please check your fuel tank. <ul style="list-style-type: none"> → Is there any fuel inside? ● Please check the wiring. <ul style="list-style-type: none"> → Do you connect the wiring correctly? ● Please check the setting. <ul style="list-style-type: none"> → Please refer to the manual 4-9.
Temp does not appear or appear incorrectly.	<ul style="list-style-type: none"> ● Please check the sensor. <ul style="list-style-type: none"> → Does the wiring break or falling off? ● Do you connect the wiring correctly. <ul style="list-style-type: none"> → Please check the positive wire (Red) connects to the battery, and main switch positive wiring (Brown) connects to the main switch.

※: If still can't solve the problems according to the steps above, please contact with distributors or us.

7 Guarantee & notice of products

We hope our products are perfect. Should it happened that our products were bad qualities, we would do our best to exchange the same items to you. Furthermore, we apologize we could not exchange the items with breakdowns or damages by human. (The guarantee standards are on the basis of the following rules.)

The guarantee rules of products

1. Problems are happened when normal operating according to the notes of the manual in the guarantee time, please bring to distributors or us and we will repair for free.
2. If breakdowns are happened in the guarantee time, please bring to distributors or us and present us the guarantee and the details describing the damages situations.
3. It couldn't be repaired if a prize, but can contact with us.
4. We will charge you for repairing under the following situations even in the guarantee time:
 - (1) No guarantee.
 - (2) No customer's name, purchase date, distributor's name, and/or change the characters in the guarantee.
 - (3) The damage is caused by being operated with mistakes, repaired roughly, disassembled and refitted.
 - (4) The damage is caused by being fell down to the ground or being watered.
 - (5) The damage is not caused by the electric power. for example: fire, earthquake, wind, rain, thunder, or visitation etc.
5. The guarantee is only available in your country.

※: The guarantee time is an advantage of consumers for repairing free. If your product needs to be repaired but the guarantee time has passed or you don't remember where you bought, please contact with us.

8 Guaranty

Notice

- ◎ Distributors need to note the date and stamp when selling.
- ◎ Show this guaranty if problem happened and send to distributor.
(Please refer to guarantee & notice of products)
- ◎ No refund.
- ◎ No cleaning the surface with gasoline.
- ◎ Please read the manual guide carefully.

Model: RX2N		
Date of purchasing:	year	month day
Name:	Guaranty period: 6 months	
Tel.:	Distributor stamp	
Address:		
No.:		

KOSO  **Tong Yah Technology Co., Ltd**

No. 405 DING-AN ST. ANNAN DISTRICT TAINAN CITY 70944 TAIWAN

Tel: +886-6-2556565 Fax: +886-6-2461878

http://www.koso.com.tw E-mail: info@koso.com.tw

COPYRIGHT RESERVED

RX2N 

RX2N 